



Thermoelectric Cooler Performance Specifications

TEC1-032080-44X55 W150mm

Hot Side Temperature(°C)	25 °C	50 °C
Qmax (Watts)	17.3	20.4
Delta Tmax(°C)	67	75
I _{max} (Amps)	8.5	8.5
V _{max} (Volts)	3.9	4.1
Module Resistance(Ohms)	0.39	0.44

**Tolerances for thermal and electrical parameters ± 10%.



Performance Curves Th=25 °C

Performance Curves Th=50 °C

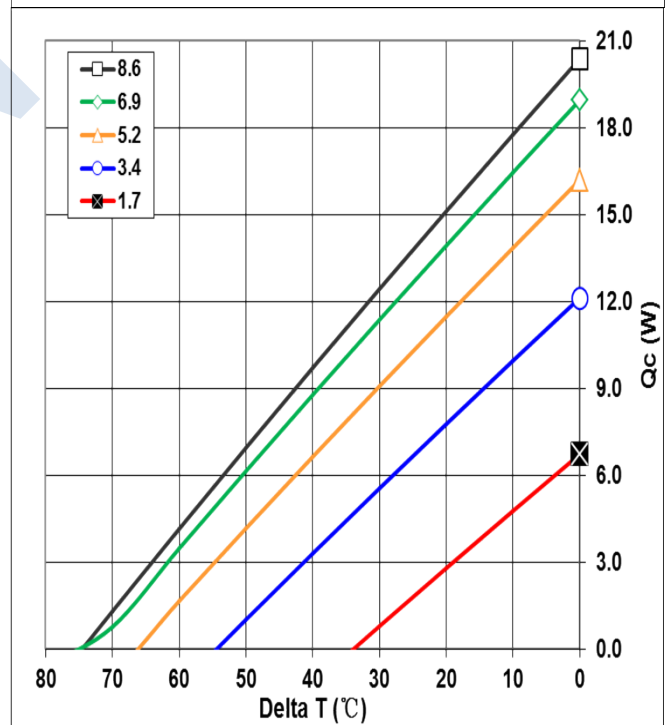
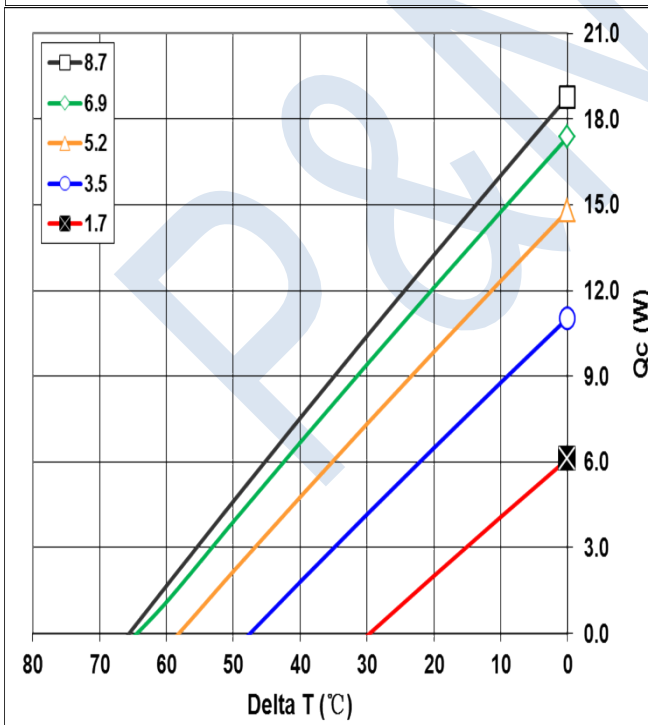
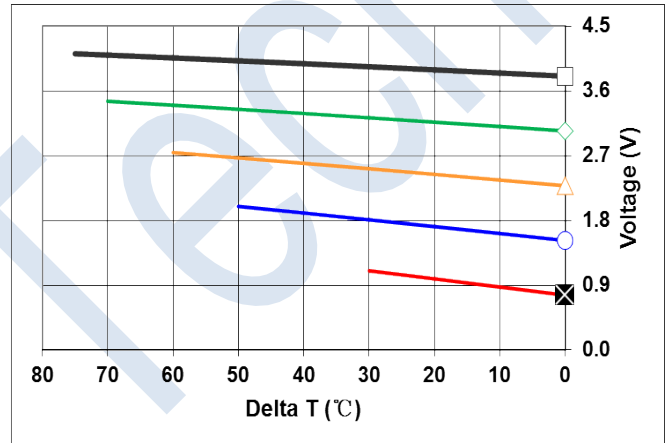
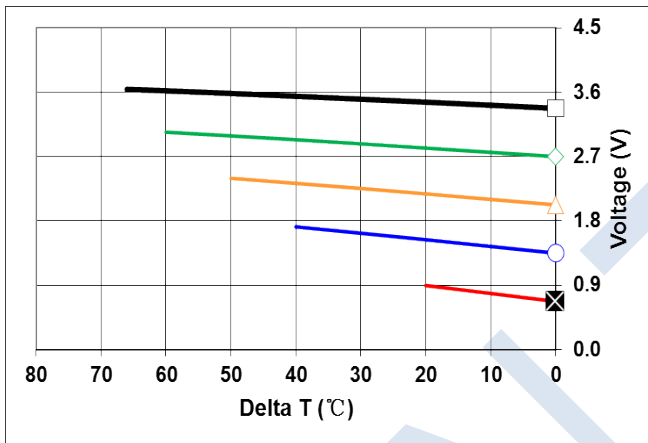

Mechanical Drawing:

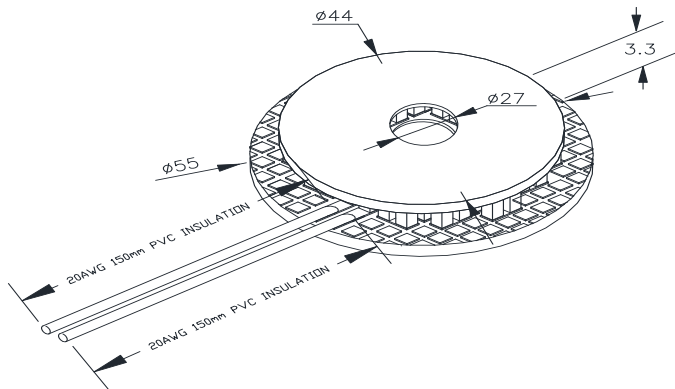

Operation Tips:

- Max Operating Temperature: **90°C**.
- Do not exceed I_{max} or V_{max} when operating module.
- Please consult P&N Technology for moisture and corrosion protection options.

Address: 5/F Xinfei Building 28th Xiangming Road, Torch (xiang'an) Hi-tech Zone, Xiamen Fujian China.

Sales Tel: + 86 - 592 - 352 1988

Fax: +86-592-352 1989

Postcode: 361 011

Web: www.pengnantech.com